

# devola

Comfortable living everyday

## Instruction Manual



## Devola Air Purifier

DV150APQM  
DV150APQMFT



[devola.co.uk](http://devola.co.uk)

---

## Contents

1. Important safety instructions .....	01
2. Product Structure .....	02
3. Before first use.....	03
4. Using the appliance .....	05
5. Filter Replacement .....	07
6. Storage .....	09
7. Environment .....	09
8. Troubleshooting .....	10

---

# 1. Important Safety Instructions

When using electrical appliances, basic safety precautions should always be followed to reduce the risk of fire, electric shock, and injury to persons. These precautions include:

1. Read all instructions before using the appliance.
2. To avoid fire or shock hazard, plug the appliance directly into correct electrical outlet.
3. If the Filter is covered by a bag when shipped, remove plastic bag before use.
4. Keep the cord out of heavy traffic areas. To avoid fire hazard, NEVER put the cord under rugs, near heat registers, radiators, ovens, or heaters.
5. To protect against electrical hazards, DO NOT immerse the appliance in water or other liquids. Do not use near water.
6. Close supervision is necessary when any appliance is used by or near children, or disabled persons.
7. Always unplug the air purifier before moving or cleaning the unit, opening the grill, changing the filter and whenever the unit is not in use. To disconnect the unit, be sure to pull the plug and not the cord.
8. NEVER drop or insert any objects into the openings of the unit.
9. DO NOT operate any appliance with a damaged cord or plug.
10. Use the appliance only for intended household use as described in this manual. Any other use not recommended by the manufacturer may cause fire, electric shock, or injury to persons. The use of attachments not recommended or sold by manufacturer may cause hazards.
11. DO NOT use outdoors.
12. NEVER place on a soft surface such as a bed or sofa as this could cause the unit to tip over and block the air inlet or outlet grills.
13. Keep unit away from heated surfaces and open flames.
14. DO NOT attempt to repair or adjust any electrical or mechanical functions on this unit. Doing so will void your warranty. The inside of the unit contains no user serviceable parts. All servicing should be performed by an authorized electrician or person.
15. DO NOT place anything on top of unit.
16. NEVER use detergents, gasoline, glass polish, furniture polish, paint thinner, or other household solvents to clean any part of the appliance.
17. Always turn the appliance off before unplugging it.
18. This appliance should only be used in room with temperatures between 5°C and 43°C.
19. **WARNING:** To reduce the risk of fire or electric shock, DO NOT use the appliance with any solid-state speed control device.

**PLEASE READ AND SAVE THESE IMPORTANT SAFETY INSTRUCTIONS**

---

## 2. Product Structure

Thank you for purchasing our air purifier, before use please read this manual carefully to operate the product correctly.

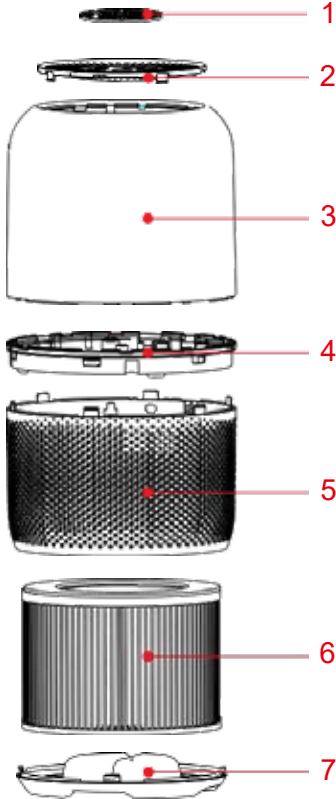

- 1. Control panel
- 2. Outlet cover
- 3. Upper body
- 4. Decorative ring
- 5. Lower body
- 6. Filter
- 7. Base cover

### 3. Before first use

#### Placing the filters

The appliance comes with all filters fitted inside, but you must remove the packaging of the filters before you can use the appliance. Remove all filters, unpack them, and place them back into the appliance as described below.

**Note:** Make sure you insert the filters in the correct position.

1. Put the appliance upside down on a soft cloth to avoid scratching. To open the base cover, you need to find an arrow point ▲ on the base cover corresponding the **LOCK** position, turn the base cover counterclockwise from **LOCK** to **OPEN** position, then the lock released.

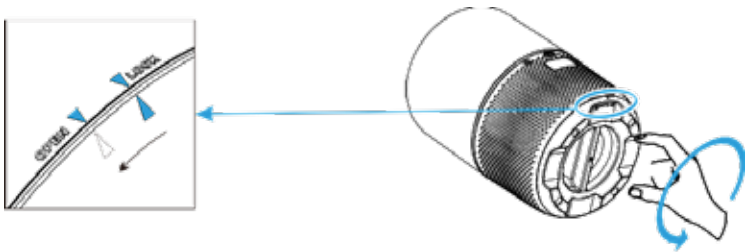

2. Remove the base cover and take out the filter.
3. Remove the packaging material from the filter.

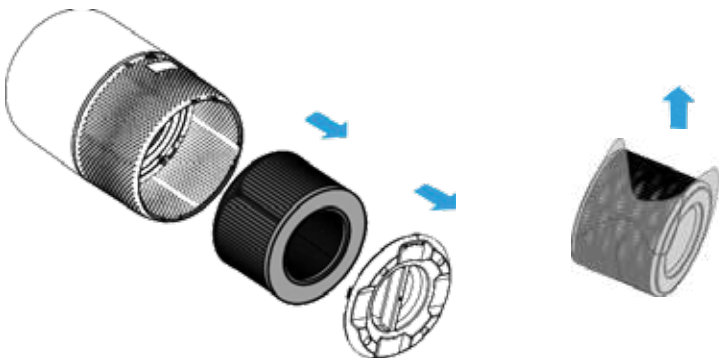

4. Put the filter back into the appliance.

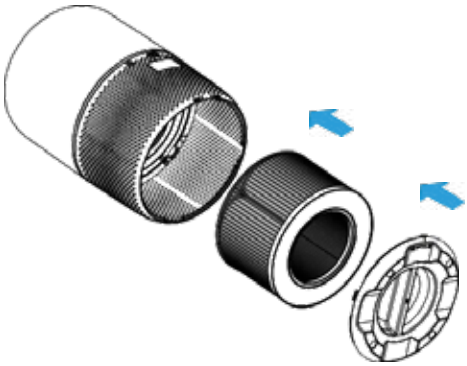

5. Turn the base cover clockwise from **OPEN** position to **LOCK** position, you will hear a "click" sound, the base cover is fastened.

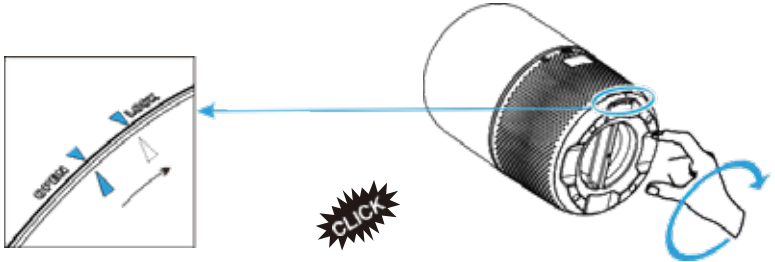

## 4. Using the appliance

### 4.1 About the control panel

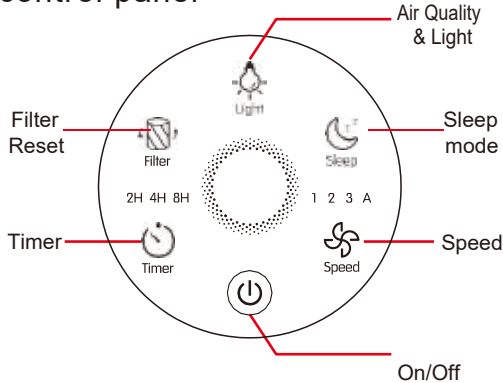

#### 1). Put the plug in the wall socket

The display lights will turn on and you will hear a beep. The lights then turn off.

#### 2). Press the power button to switch on the appliance.

The power  lights, AQ light on and FAN SPEED 1 light (Low) on the control panel will turn on.



#### 3). Fan speed adjustment

The fan speed light indicates the fan speed at which the appliance is operating. Press Speed button  to adjust fan speed level, there are four levers 1~3 refers to **Low**, **Medium**, **High level** and **Auto mode**.

At Auto mode, the fan speed will be automatically adjusted according to AQI level as below:

AQ Colour	Blue	Green	Orange	Red
Speed mode	Sleep	1(Low)	2(Medium)	3(High)
AQ level	Very good	Good	Unhealthy	Hazardous

#### 4). Sleep mode

When you use the appliance in Sleep mode, it works very quietly. Only the  and  light will be on, press any other buttons besides the Timer and Filter Reset button to exit Sleep mode.

---



## 5). AQ Light

Working status (Air quality light)



The air quality light color will automatically change according to the detecting result of sensor.

Please see the chart on page 5 for colour indicator meaning.

Standby status (Night light mode)

- 1). In standby, press  button and the amber light will turn on.
- 2). Press the  button again and the light will dimmer to the half-light setting. To turn off the night light, just press the button  for a third time. The light cycles as follow, Bright, Half brightness, Off.

## 6). Setting timer

1. Press  to turn the timer on or off, and to cycle through timer options (2 hours, 4 hours, or 8 hours).
  2. The air purifier will automatically switch off once the timer is finished.
- NOTE: Pressing  or unplugging the air purifier will cancel the timer.

## 7). Filter Replacement Light

When the indicator  light is on, it means that you should check the filter to see if it needs to be cleaned or replaced.

**Note:** The filter's lifetime is based on your house air quality and usage. Using the appliance in a humid environment will reduce the lifetime of the filter.

## 8). Memory Function

The air purifier has a setting memory function, meaning that when the users turn it off, it will return to the last setting once it gets turned back on.

## 4.2 Cleaning the Air Purifier

Regularly clean the inside and outside of the body to prevent dust from collecting on the inside and outside.

- 1). Wipe away dust with a soft dry cloth from the body of the appliance.
- 2). Clean the air inlet and the air outlet with a soft dry cloth.

**Note :**

- Always unplug the appliance before you clean it.
- Never immerse the appliance in water or any other liquid.
- Never use aggressive or flammable cleaning agents such as bleach or alcohol to clean any part of the appliance.
- The filter is NOT washable.



# 5. Filter Replacement

## When Should I Replace the Air Filter?

It is recommended to change the air filter every 6–8 months. However, you may need to change your filter sooner or later depending on how often you use your air purifier, the air quality and the humidity of the environment. It is important to watch out for the following signs of expired filter:

- Increased operating noise
- Decreased airflow
- Clogged filter
- Increased presence of odours

### NOTE:

- The environment in which the air purifier is being used can extend or shorten the lifetime of the air filter. Using your air purifier in an environment of relatively high pollution may mean you will need to change the air filter more often.
- If the air pollution in your environment is very high, there is a possibility that the filters may not be completely effective and may need to be replaced before  lights up.
- Remember to reset the air purifier after changing the air filter.

1. Switch off the appliance and unplug it. (a)



(a)

2. Put the appliance upside down on a soft cloth to avoid scratching, to open the base cover, you need to find an arrow point ▲ on the base cover corresponding the **LOCK** position, turn the base cover counterclockwise from **LOCK** to **OPEN** position, then the lock released. (b)

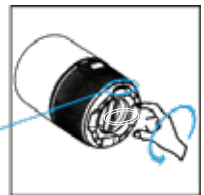

(b)

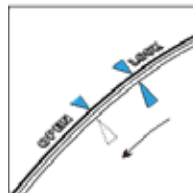

3. Remove the old filter. (c)

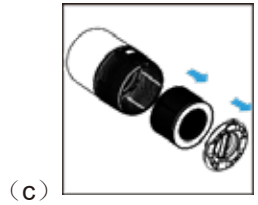

4. Remove the packaging material of the new filter. (d)

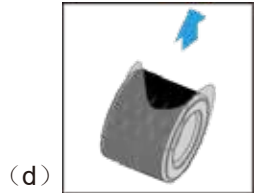

5. Put the new filter back into the appliance. (e)

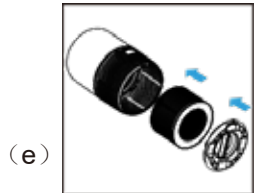

6. Turn the base cover clockwise from **OPEN** position to **LOCK** position, you will hear a "click" sound, the base cover is fastened. (f)

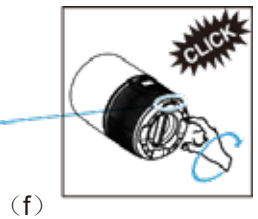
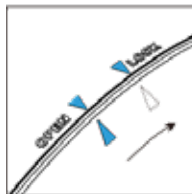



7. Put the plug in the wall socket and switch on the appliance again. (g)



## 8. Reset Filter's lifetime.

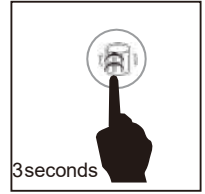

The filter lifetime should be reset if  lights up, after replacing the new filter, you need to reset filter lifetime.

- 1). Plug in the air purifier and turn it on.
- 2). Press and hold  for 3 seconds.
- 3). Release  and the light will turn off, indicating (h) that the reset is complete.



## Filter replacement force mode

When using the air purifier in an environment of heavy pollution, the lifespan of the air filter may be significantly reduced. You can change the filters even if  does not light up. Follow the steps below to perform a hard reset.

- 1). Replace the air filters as mentioned in the Filter Replacement section.
- 2). Plug in the air purifier and keep in standby mode.
- 3). Press and hold  for 3 seconds, and it will light up.
- 4). Press and hold  again for 3 seconds, and it will turn off. The reset is now complete.

## 6. Storage

Unplug the power cord, then wipe the machine clean, put the appliance in the packing bag, then store in a dry place.

## 7. Environment

Do not throw away the appliance with the normal household waste at the end of its life, but hand it in at an official collection point for recycling. By doing this, you help to preserve the environment.

## 8. Troubleshooting

This chapter summarises the most common problems you could encounter with the appliance. If you are unable to solve the problem with the information below, contact the Consumer Care Centre in your country.

Problem	Cause	Solution
Air purifier does not power on.	Unit is not plugged into an electrical outlet.	Connect the plug to a powered electrical outlet.
	Outlet is not working properly.	Try plugging the air purifier into a different outlet.
	Power button has not been pressed after plugging in the air purifier.	Press '⏻' once to turn on the air purifier.
	Power cord is damaged.	Immediately discontinue use and contact Customer Support.
	Air purifier is defective or malfunctioning.	
Air purifier does not respond to button controls.	Air purifier is not plugged into an outlet.	Connect the plug to a powered electrical outlet.
	Air purifier is defective or malfunctioning.	Immediately discontinue use and contact Customer Support.
Air purifier makes an unusual noise while operating.	Air filters are dirty.	Replace the air filters as instructed in the <b>Filter Replacement</b> section.
	Filter does not fit properly.	Properly place filter(s) as noted in the <b>Before first use</b> and <b>Filter Replacement</b> sections.
	Foreign object inside the unit.	Immediately discontinue use and contact Customer Support. <b>DO NOT</b> attempt to open the air purifier.
Significantly reduced airflow.	Filter packaging has not been removed.	Remove filter from packaging before use.
	Fan speed is low.	Press '⏻' to adjust fan speed.
	Air filters need to be replaced.	Replace the air filters as instructed in the <b>Filter Replacement</b> section.
	Not enough clearance on all sides of the purifier.	Ensure there is at least 38 cm (15 inches) of clearance on all sides of the purifier.
Poor air purification quality.	Air filters need to be replaced.	Replace the air filters as instructed in the <b>Filter Replacement</b> section.
	Room is too large for the air purifier's applicable area.	Ensure the room is smaller than (280 ft <sup>2</sup> ).
	Air inlet or outlet is blocked.	Remove objects blocking air inlet or outlet.
	Filters not properly placed in housing.	Properly place filters as noted in the <b>Before first use</b> and <b>Filter Replacement</b> sections.
Filter reset button is still illuminated after replacing the air filters.	The air purifier has been reset incorrectly.	See the <b>Filter Replacement</b> section on how to properly reset the unit.
Air purifier turns on, then suddenly turns off.	Air purifier is defective or malfunctioning.	Immediately discontinue use and contact Customer Support. <b>DO NOT</b> attempt to open the air purifier for self-servicing.
Air purifier beeps repeatedly after being powered on or plugged in.		



## Product Registration

Register your warranty online  
within 30 days of purchase.

[www.devola.co.uk/warranty](http://www.devola.co.uk/warranty)



10% OFF

Use this discount code on your next order

**DEV10**



## View Online

DV150APQM



DV150APQMFT



[devola.co.uk](http://devola.co.uk)

Unit 1, Reedswood Park Road, Walsall, West Midlands. WS2 8DQ

Helpline 0800 043 8975 Email [info@devola.co.uk](mailto:info@devola.co.uk)