

0

Product Registration

www.devola.eo.uk/warranty

10% OFF

DEVIO

Scan for technical details



d o l

Comfortable living everyday

Instruction Manual

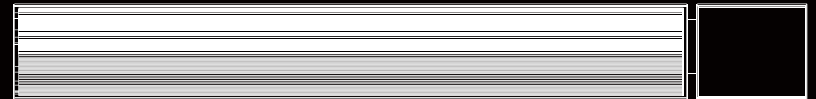

DVRH1200B, DVRH1800B



Congratulations on the purchase of your new Devol□ product. Please read the following instructions carefully and follow them to prevent possible damages. We assume no liability for damage caused by disregard of the instructions and improper use.

INDEX

- 01. SAFETY INSTRUCTIONS
- 03. INSTALLATION
- 05. OPERATION
- 07. OPERATION VIA WIFI
- 08. USING THE SMART LIFE APP
- 11. OTHER FEATURES
- 12. TECHNICAL DATA

Correct Disposal of this product



This marking indicates that this product should not be disposed with other household wastes throughout the EU. To prevent possible harm to the environment or human health from uncontrolled waste disposal, recycle it responsibly to promote the sustainable reuse of material resources. To return your used device, please use the return and collection systems or contact the retailer where the product was purchased. They can take this product for environmentally safe recycling.

TECHNICAL DATA

Type	Power	Length (mm)	Width (mm)	Height (mm)
DVRH1200B	1200W	940	150	65
DVRH1500B	1800W	1240	150	65

ERP LABEL

Model identifier(s): DVRH1200B DVRH1500B						
Item	Symbol	Value	Value	Unit	Item	Unit
Heat output					type of heat input, for electric storage local space heaters only (select one)	
Nominal heat output	P _{nom}	1.2	1.8	kW	manual heat charge control, with integrated thermostat	No
Minimum heat output (indicative)	P _{min}	0.6	0.9	kW	manual heat charge control with room and/or outdoor temperature feedback	No
Maximum continuous heat output	P _{max,c}	1.1	1.8	kW	electronic heat charge control with room and/or outdoor temperature feedback	No
Auxiliary electricity consumption					fan assisted heat output	
At nominal heat output	el _{nom}	1.137	1.760	kW	type of heat output/room temperature control (select one)	
At minimum heat output	el _{min}	0.567	0.878	kW	single stage heat output and no room temperature control	No
In standby mode	el _{SB}	0.3	0.4	W	Two or more manual stages, no room temperature control	
					with mechanic thermostat room temperature control	No
					with electronic room temperature control	No
					electronic room temperature control plus day timer	Yes
					electronic room temperature control plus week timer	No
Other control options (multiple selections possible)						
					room temperature control, with presence detection	No
					room temperature control, with open window detection	Yes
					with distance control option	Yes
					with adaptive start control	No
					with working time limitation	No
					with black bulb sensor	Yes
Contact details						

SAFETY INSTRUCTIONS

BEFORE FIRST USE

Read and follow all the instructions in this manual even if you feel you are familiar with the product and find a place to keep it handy for future reference.

NOTE: The rating of this product (as marked on the product rating label) is based on specific loading tests. Normal use or the use of other recommended attachments may draw significantly less power.

IMPORTANT SAFEGUARDS

When using any electrically powered product, basic safety precautions should always be followed.

PLEASE READ THE FOLLOWING INSTRUCTIONS CAREFULLY BEFORE USING THE PRODUCT.

WARNING - TO REDUCE THE RISK OF FIRE, ELECTRICAL SHOCK OR INJURY TO PERSONS OR PROPERTY:

- Read all instructions before using this appliance and keep them for future reference.
- Before use, check that the heater and all supplied accessories are present and intact.
- Use only the voltage specified on the rating plate of the heater.
- Do not cover the grilles or block entry or exit of air flow by placing appliance against any surface. Keep all objects at least 1 metre from the front, side and rear of appliance.
- Do not place the product close to a radiant heat source.
- Do not use in areas where gasoline, paint or other flammable liquids are used or stored.
- **CAUTION-** Some parts of this product can become very hot and cause burns. To avoid burns, do not allow bare skin to come in contact with the heater while it is in use. Particular attention should be given where children and vulnerable people are present.
- Do not immerse the heater in liquid or allow liquid to enter the interior of the heater, as this could cause an electric shock.
- Do not operate the appliance if the cord or plug are damaged, or if the appliance malfunctions or has been dropped or damaged in any manner. Seek assistance from a qualified electrician for any mechanical adjustments, service or repairs.
- Do not touch the appliance with wet hands.
- The most common cause of overheating is deposits of dust or fluff in the heater. Ensure these deposits are removed regularly by unplugging the heater and vacuum cleaning air vents and grilles.
- Use a soft damp cloth to clean the appliance. Ensure that it is switched off and disconnected from the mains beforehand.
- Do not connect the appliance to the mains voltage until it is fully installed in the desired position.
- Do not use the appliance in the immediate surroundings of a bath/shower, swimming pool or any liquid container.
- Switch off and let the surface cool before moving and storing.
- We do not recommend use of an extension lead to operate this appliance.
- Please ensure that the power supply is switched off when the appliance is not in use.
- Do not allow the cord to come into contact with the heated surface during operation.
- **CAUTION:** This heater is not suitable to be used on long pile carpets or Flokati rugs.
- Do not run the cord in areas where it can cause someone to trip or fall. Do not twist, kink or warp the cord around the heater, as this may cause the insulation to weaken and split. Always ensure that cord has been removed from any cord storage area.

SAFETY INSTRUCTIONS

- If the supply cord is damaged it must be replaced by a qualified electrician to avoid a hazard.
- This appliance is not to be used by young children without supervision.
- Do not place this appliance below the socket-outlet.
- All covers of this appliance are intended to protect direct access to the heating elements and must be in place when the appliance is in operation. Please only use this product as per its intended use outlined in this manual. Any other use is not recommended by the manufacturer and may cause fire, electric shock or injury.
- Children of less than 3 years should be kept away from the appliance unless continuously supervised. Children should not plug in, clean or perform user maintenance on the appliance at any time.
- When installing the heater, please ensure that it is at least 1.8m above Floor level.
- **WARNING:** This heater is not equipped with a device to control the room temperature. Do not use this heater in small rooms when they are occupied by persons not capable of leaving the room on their own, unless constant supervision is provided.

OTHER FEATURES

SCENES

"Scenes" bring all your devices together to respond to environmental conditions. Triggers of events include the temperature, humidity levels, air quality, sunrise and sunset, and device behavior. So, for example, you could set your windows to close every time your heater switches on; or set your lights to switch on, curtains to close and heater to switch on whenever the sun sets. Only devices connected to the app can be used in scenes.

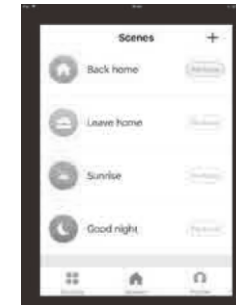

SHARING

You can share control of your devices with family members. Go to "device sharing", toggle which devices you want to share, and tap Share with New Member. You can then add their email address or phone number. If they have the app, the device will appear on their device list. If they don't have the app, they will be sent a link to download the app.

Note you can only share to numbers and email addresses that are connected to app-compatible devices: smartphones or tablets.

VOICE INTEGRATION

Smart life is compatible with both Amazon Echo and Google Home.

FAQs

Find the answer to many troubleshooting problems in the app's FAQ section.

SCHEDULING YOUR HEATING

You can program your heating by creating a schedule of "events", where the heater switches on or off. These events can be temporary, like setting a timer, or they can be recurring, so the heater switches on at the same time every week. You can set an unlimited number of events, switching the heater on and off across the week.

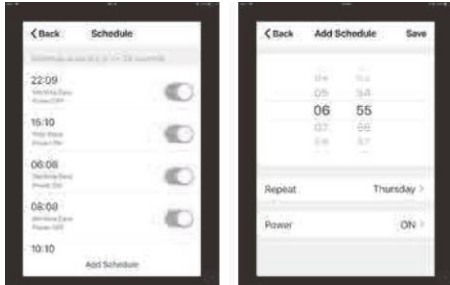

For every event, you must set a start time. Then, choose whether you want it to repeat. Select "Only Once" if you just want to set a timer for now. If you want the event to repeat, select which days you want it to occur. Finally, choose whether you want the heater to switch on or off. Make sure you confirm your settings at every stage and press save to keep the event.

Each event will appear in your schedule. You can activate and de-activate events using the toggle. You can also delete events by swiping left and tapping Delete.

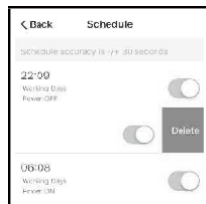

The heater will beep when it begins a new heating event. The heater will heat at whatever mode it was last set to and you cannot schedule mode changes. Note, if you change the heater's setting during an event - i.e. turning it on when it is scheduled to be off - the heater will remain as it is until the next scheduled event.

INSTALLATION

WALL INSTALLATION



1. Use the screws to install two of the fixed frames to the device, as shown in figure A.
2. Use the screws to install the fixed frames to the wall or ceiling, as shown in figure B.
3. Affix the device to the chosen area with screws, as shown in figure C.

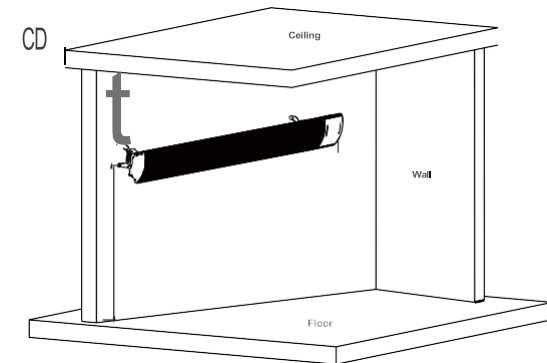

The Heater must be installed at a minimum of 1.8m from the floor and requires at least 20cm distance from the ceiling and walls.

CEILING INSTALLATION

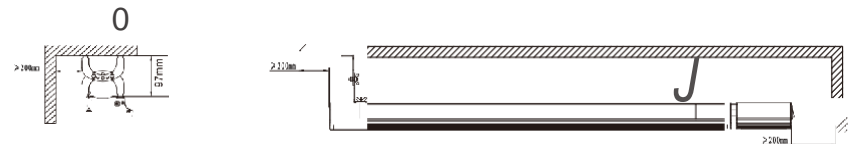

The device must be installed at least 200mm from the wall, as shown in figure 2.

DOUBLE HANGING CEILING INSTALLATION

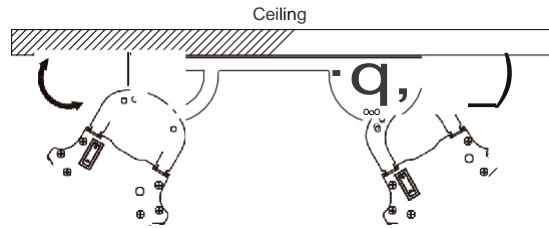

Two electrical appliances are connected through a connecting frame installed on the ceiling. (Additional parts sold separately)

EXTENDED INSTALLATION

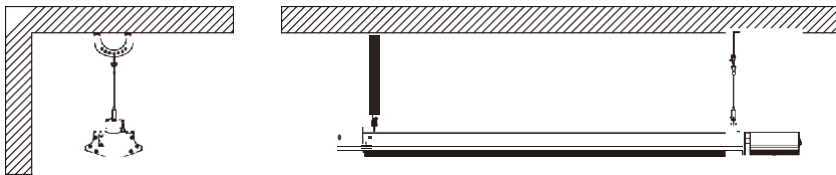
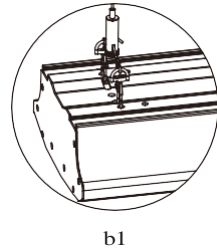
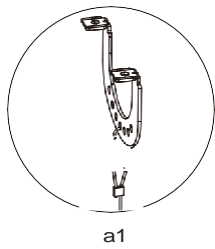

Sling appliances will hook up and hang from the ceiling. (Additional parts sold separately)

USING THE SMART LIFE APP

- Offline (Device is off the wall)
- Turned Off (Device is in standby mode)
- Turned On (Device is in heating mode)



When the heater is online, tap the device name to go to the control interface. Note: when the heater is online, you will not be able to control it with the app.

CONTROLLING THE HEATER

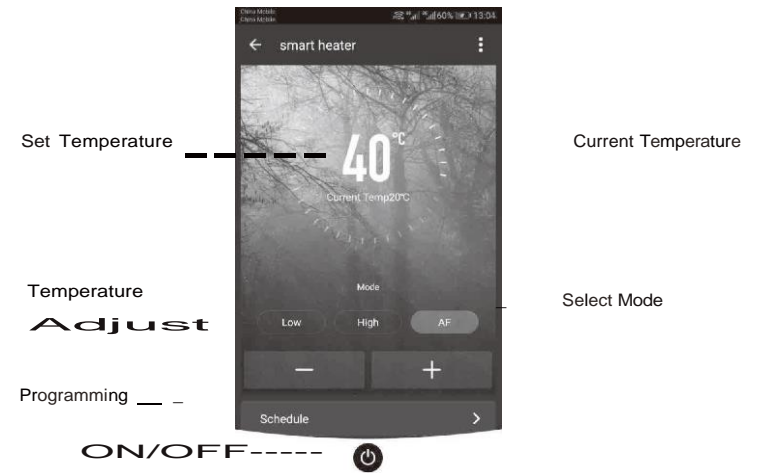

You can change the heater's current mode by tapping the mode buttons. You can adjust the mode's temperature using the + and - buttons when you're on that mode.

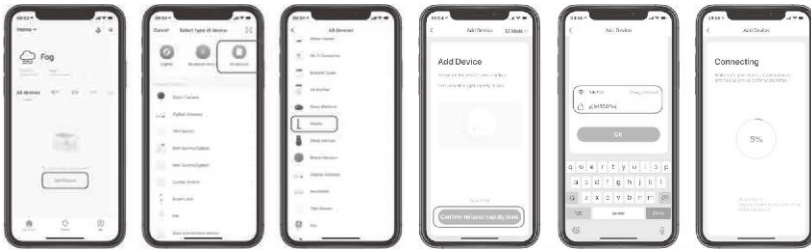

4. The opp will then display its connecting screen, as per the image below.



NOTE: The heater has two connection modes: one where the Wi-Fi icon Flashes slowly (once per second) and one where the Wi-Fi icon Flashes quickly (three times per second). Most devices will connect via the mode where the icon is blinking rapidly (EZ Mode). If the heater is failing to connect in EZ mode, hold the button on the control panel for three seconds. The heater will then switch to its secondary connection mode (AP Mode). You must ensure that the heater and smartphone/tablet are operating in the same mode to pair the devices. If you switch to the AP mode on the heater, you must also do the same on the smart device. Press EZ mode in the top right-hand side of the display and select AP Mode from the dropdown menu to switch the mode (see below image for reference).

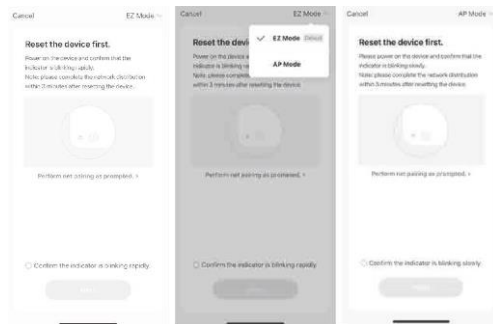

5. The heater will beep and display a solid Wi-Fi icon when the device is connected.

The opp will confirm that the heater has been added. You can now name the device, share it with family members, or proceed to scheduling your heating.

OPERATION

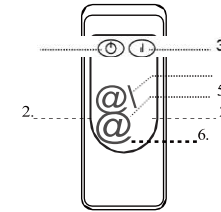

1. On/ off button
2. Adjustment button
3. High/low switch button
4. Switch button
5. Set button
6. Display button

HEATER CONTROL

Switch On

Press "1." to turn the heater on and the screen will display the room temperature.

If the current room temperature is lower than the pre-set temperature the heating function will begin to operate, and the indicator light will blink.

NOTE: When the heater is fast used you may detect an odor. This is because the protective layers of oil that the devices elements are coated in during production will burn off in fast use. This should not cause concern and you should allow the appliance to heat up in an open environment to make the smell disappear.

Lock Function

Press "4." followed by "1." and the "LOCK" indicator light will illuminate. All keys are invalid when the lock function is activated.

Display Screen On/Off

Press "6." to switch off the display. Press the "6." button again for the display to illuminate.

Temperature Setting

To set the temperature press "5." then press "2." to increase or decrease the temperature by 1°C. The maximum temperature is 45°C. Once the desired temperature is set the system will automatically update and return to its normal operational status where the screen displays the room temperature.

Timing Switch Setting

Press "5." and the "00" will Flash, use "2." to set the time. The minimum time set up is 1 hour and the maximum is 24 hours. Each time you press "2." the time will increase or decrease by 1 hour. When the time is set the system will automatically save and return to its normal operating status, however, it will now display the time on the screen.

Open Window Detection

When the temperature reduces by 3°C or more within two minutes the intelligent window detection function kicks in and the heater will stop working. The LED display will flash and the heater will make a clicking sound. The heater will only resume working when it is manually reset by hand.

Press "4" button and then immediately press "5" button and hold this button for 5 seconds.

Now the Open Window function is activated and the display shows "ON". "ON" will flash for 5 seconds and after that the display will change to the original display.

Press "4" button and then immediately press "5" button and hold this button for 5 seconds again will turn "OFF" the Window Function.

Note: Open Window function is turned OFF in factory setting.

Wi-Fi reset setting (with Wi-Fi model)

When the heater is in operation press "4." followed by "3." within 5 seconds. Then hold "2. (up)" for around 10 seconds and the Wi-Fi will reset.

Bluetooth connection requirements

1. You must use a mobile phone device that is successfully connected to the heater.
2. Ensure the Bluetooth function is activated on the mobile phone.
3. The user must be in proximity of the heater.
4. If the network becomes bad or the phone cannot be controlled by Wi-Fi, wait for 3-5 minutes for the device to connect to Bluetooth to continue operation.

High/Low Setting

When the heater is in operation press "3." to switch between the high and low heating setting.

Temperature Change(choice):

Press the "4" ,then press "3",press"2"within 5 second,the temperature can change between Fahrenheit and Celsius.

Switch Off

Press "1." to turn off the device.

OPERATION VIA WIFI

To operate your heater using Wi-Fi, the first step is to download the Smart Life app onto your smartphone or tablet. You can find the app by scanning the QR code below or searching "Smart Life" in Google Play or App store.



2. Download and install the app. Unless you already have a registered Smart Life account, you will need to create an account by tapping Register.



The device will automatically determine your country, although you can change this if necessary. Enter your phone number or email address. If you enter a phone number, a verification number will be sent to your phone: enter this number to verify, then create a password. If you enter your email address, you will need to create a password.

3. To add your heater to the app, first put the heater in Wi-Fi connection mode. The heater is in Wi-Fi connection mode when the Wi-Fi icon is flashing. If the icon is not flashing, hold down the power button for three seconds to reset the Wi-Fi.
4. Once the Wi-Fi icon is flashing, go to the app and press Add a Device. Select the device type (heater) in the Small Home Appliances tab and confirm that the indicator is flashing. You will then be prompted to enter your Wi-Fi password. This allows the app to find your heater using Wi-Fi. Your Wi-Fi must be running at 2.4GHz frequency as opposed to 5GHz, otherwise the heater will not connect to the app.