



Product Registration

Register your warranty online
within 30 days of purchase.

www.devola.co.uk/warranty



10% OFF

Use this discount code on your next order

DEV10



Scan for technical details



devola.co.uk

Unit 1, Reedswood Park Road, Walsall, West Midlands. WS2 8DQ

Helpline 0800 043 4243 Email info@devola.co.uk

devola

Comfortable living everyday

Instruction Manual

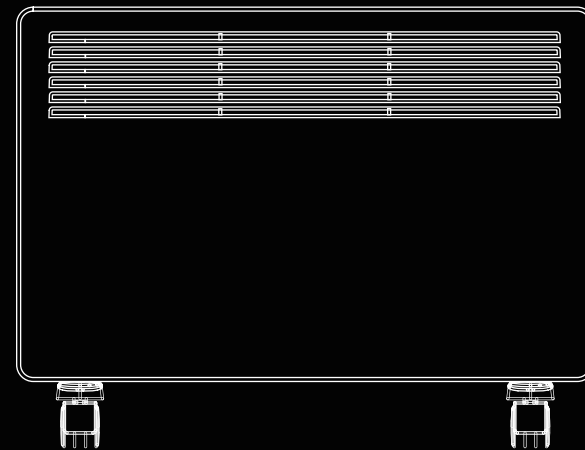

Devola Eco Panel Heater With 24/7 Timer

DVNDM10, DVNDM15,
DVNDM20, DVNDM24



devola.co.uk

Thank you for the purchase of your new Devola panel heater. Please read the following instructions carefully and follow them to prevent possible damages. We assume no liability for damage caused by disregard of the instructions and improper use.

INDEX

01. SAFETY INSTRUCTIONS

03. APPLIANCE OVERVIEW

Control Panel

04. INSTALLATION

Clearances

Mounting Guide

Caster Installation & Removal

06. OPERATION

Getting Started

Power On

Setting the Date and Time of Heater

Setting the Temperature

Setting the Timer

Setting the Timer in Auto Mode (Weekly Timer)

Delete Timers

Power Off

Half and Full Power Selection

Manual Mode And Auto Mode

Shutdown Memory Function

Switching Off The Electrical Memory Function

Open Window Detection

Delete Open Window Detection

Signal Sound

Child Lock

Unlock Child Lock

10. CLEANING & MAINTENANCE

11. SPECIFICATION

SPECIFICATION

Model Number	DVNDM10	DVNDM15	DVNDM20	DVNDM24
Rated Power	500W/1000W	750W/1500W	1000W/2000W	1200W/2400W
Rated Voltage	220-240V~ 50Hz			
Dimensions(mm)	W460 x D107x H400	W595 x D107x H400	W830 x D107x H400	W950 x D107x 400
Room Coverage (m ²)	12	17	22	26
IP Rating	IP24			
Cable Length	1.5m			
Clearances	Minimum of 1m from wall/ceiling			
Colour	White			

Table of information - requirements for electric local space heaters						P
Item	Symbol	Value				Unit
Model identifier(s):		DVNDM10	DVNDM15	DVNDM20	DVNDM24	
Heat output						
Nominal heat output	P _{nom}	1.0	1.5	2.0	2.4	kW
Minimum heat output (indicative)	P _{min}	0.5	0.75	1.0	1.2	kW
Maximum continuous heat output	P _{max.c}	0.96	1.48	1.98	2.32	kW
Auxiliary electricity consumption						
At nominal heat output	el _{max}	0.966	1.485	1.985	2.322	kW
At minimum heat output	el _{min}	0.478	0.720	0.979	1.165	kW
In standby mode	e _{lSB}	0.0004	0.00035	0.0004	0.0004	kW
Item						
Type of heat input, for electric local space heaters						
Manual heat charge control with integrated thermostat						[no]
Manual heat charge control with room and/or outdoor temperature feedback						[no]
Electronic heat charge control with room and/or outdoor temperature feedback						[no]
Fan assisted heat output						[no]
Type of heat output/room temperature control						
Single stage heat output and no room temperature control						[no]
Two or more manual stages, no room temperature control						[no]
With mechanic thermostat room temperature control						[no]
With electronic room temperature control						[no]
Electronic room temperature control plus day timer						[no]
Electronic room temperature control plus week timer						[yes]
Other control options						
Room temperature control, with presence detection						[no]
Room temperature control, with open window detection						[yes]
With distance control option						[no]
With adaptive start control						[no]
With working time limitation						[no]
With black bulb sensor						[yes]
Remark:						
For electric local space heaters, the measured seasonal space heating energy efficiency η_s cannot be worse than the declared value at the nominal heat output of the unit.						

SAFETY INSTRUCTIONS

BEFORE FIRST USE

Read and follow all the instructions in this manual even if you feel you are familiar with the product and find a place to keep it handy for future reference.

NOTE: The rating of this product (as marked on the product rating label) is based on specific loading tests. Normal use or the use of other recommended attachments may draw significantly less power.

IMPORTANT SAFEGUARDS

When using any electrically powered product, basic safety precautions should always be followed.

PLEASE READ THE FOLLOWING INSTRUCTIONS CAREFULLY BEFORE USING THE PRODUCT.

WARNING - TO REDUCE THE RISK OF FIRE, ELECTRICAL SHOCK OR INJURY TO PERSONS OR PROPERTY:

- Read all instructions before using this appliance and keep them for future reference.
- Use only the voltage specified on the rating label of the heater.
- Do not cover or restrict airflow to the inlet or exhaust grilles in any manner as the appliance may overheat and become a fire risk.
- Do not cover grilles, block entry or exhaust of airflow by placing appliance against any surface. Keep all object at least 1 meter from the front, side and rear of the appliance.
- Do not place the appliance close to a radiant heat source.
- Do not operate in areas where gasoline, paint or other flammable liquids are used or stored.
- This appliance heats up when in use. To avoid burns, do not let bare skin touch hot surface.
- Switch off and leave to cool before moving.
- Do not use the appliance to dry clothes.
- Do not insert or allow foreign object or metal utensils to enter any ventilation or exhaust opening, as this may cause an electric shock, fire or damage to the appliance.
- Do not immerse in liquid or allow liquid to run into the interior of the appliance, as this could create an electric shock hazard.
- Do not reach for an appliance that has fallen into water. Switch off at supply and unplug immediately.
- Do not operate any appliance with a damaged cord, plug or after the appliance malfunctions or has been dropped or damaged in any manner. Return to a qualified electrical person for examination, electrical or mechanical adjustment, service or repair.
- Do not operate appliance with wet hands.
- The most common cause of overheating is deposits of dust or fluff in the appliance. Ensure these deposits are removed regularly by unplugging the appliance and vacuum cleaning air vents and grilles.
- Do not use this appliance near a window as rain may cause electric shock.
- Do not use abrasive cleaning products on this appliance. Clean with a damp cloth (not wet) rinsed in hot soapy water only. Always remove plug from the mains supply before cleaning.

SAFETY INSTRUCTIONS

- Do not connect the appliance to the mains voltage until completely assembled and adjusted.
- This appliance is not intended for use in outdoor locations.
- Do not use this appliance in the immediate surrounds of a bath, a shower or a swimming pool or other liquids.
- Always operate upright.
- Switch off and leave to cool before moving.
- Do not operate with cord coiled up as a build up of heat is likely, which could be sufficient to become a hazard.
- The use of an extension cord with this appliance is not recommended.
- Do not remove plug from power socket until the appliance has been switched off.
- Do not remove plug from power socket by pulling the supply cord-always grip plug.
- Always unplug appliance when not in use.
- **CAUTION:** This product is NOT suitable to be used on long pile carpets or Flokati rugs.
- Do not allow cord to come in contact with heated surface during operation.
- Do not run cord under carpeting, throw rugs or runners etc. Arrange cord away from traffic areas so that it will not be tripped over.
- Do not twist, kink or wrap the cord around the appliance, as this may cause the insulation to weaken and split. Always ensure that all cord has been removed from any cord storage area.
- Do not use outdoors or whilst standing on a damp floor.
- Do not store appliance while it is still hot.
- This appliance is not intended for use by young children or infirm persons without supervision.
- Young children should be supervised to ensure they do not play with the appliance.
- The appliance must not be located immediately below a socket-outlet.
- Do not use this appliance with another programmer, timer or any other device that switches the heater on automatically, since a fire risk exists if the appliance is covered or positioned incorrectly.
- All covers on this appliance are intended to prevent direct access to the heating elements and must be in place when the appliance is in use.
- **WARNING:** In order to avoid overloading, do not cover the heater.
- To reduce the risk of electric shock, do not immerse or expose the product or flexible cord to rain, moisture or any liquid other than those necessary for correct operation of the product. The fireguard does not give full protection for young children and for infirm persons. If the supply cord is damaged, it must be replaced by a qualified electrical person to avoid a hazard.
- Do not use this appliance outdoors or on wet surfaces. Avoid spilling liquid on the appliance.
- **CAUTION:** In order to avoid a hazard due to inadvertent resetting of the thermal cutout, this appliance must not be connected to an external switching device, such as a timer, or connected to a circuit that is regularly on and off by the utility.
- Use this appliance only as described in this manual. Any other use is not recommended by the manufacturer and may cause fire, electric shock or injury.
- This appliance is intended for domestic use.

CLEANING & MAINTENANCE

CLEANING

Do not use abrasive cleaning products on this appliance. Clean with a damp cloth (not wet) rinsed in hot soapy water only. Always remove plug from the mains supply before cleaning.

The heater requires regular cleaning to ensure trouble-free operation:

- Unplug the heater from the mains supply before cleaning.
- Ensure that the heater has been allowed to cool down completely before cleaning.
- Use a damp cloth (not wet) to wipe the exterior of the heater to remove dust and dirt.
- Use a vacuum cleaner to remove dust and fluff from around the grilles.
- Ensure the heater is dry before plugging back into the mains supply.

REPLACEMENT OF SUPPLY CORD

If the supply cord is damaged it must be replaced by a qualified person such as an electrician to prevent a hazard.

STORAGE

If you do not plan to use the heater for extended periods of time, it is recommended that the heater is cleaned and then stored (preferably in its original packaging) in a cool dry place.

- Always store the heater when not in use.
- Make sure the heater has cooled down before storing it away.

OPEN WINDOW DETECTION

- When the heater is in operation it is automatically in open window detection mode and will shut down if the ambient temperature rapidly falls below 3 degrees or more.

DELETE OPEN WINDOW DETECTION

- Open window detection is an integrated function of the heater and cannot be switched off while the unit is in operation.

SIGNAL SOUND

- An acoustic signal sounds each time a key is pressed on the unit. If a button is held continuously the unit will only signal once.

CHILD LOCK

- When the unit is in operation, press the up (10) and down (11) buttons simultaneously for 3 seconds. The control panel will now be locked. The temperature display (15) first shows "[]" and switches to solely displaying the room temperature after 5 seconds.

UNLOCK CHILD LOCK

- Method 1: Press the up (10) and down (11) buttons for 3 seconds and the child lock is deactivated.
- Method 2: Switch off the device using the power button (20). The unit will then enter standby mode.
- Method 3: Turn off the power supply by pressing the power switch (21).

APPLIANCE OVERVIEW

FIG.1



CONTROL PANEL

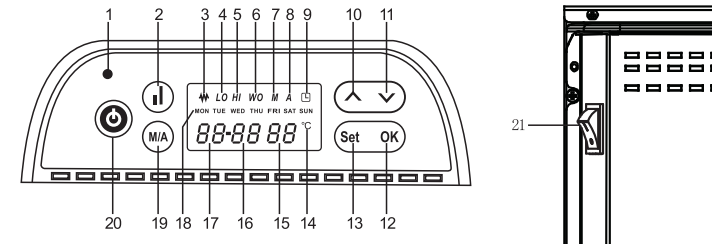

- | | |
|--|---------------------------|
| 1. Power Indicator | 12. Program Confirm (OK) |
| 2. Select Full/Half Capacity Heat Mode | 13. Program Set (Set) |
| 3. Heating Indicator | 14. Degrees Celsius (°C) |
| 4. Half Power Indicator (LO) | 15. Temperature Indicator |
| 5. Full Power Indicator (HI) | 16. Minute Indicator |
| 6. Open Window Detection (WO) | 17. Hour Indicator |
| 7. Manual Mode (M) | 18. Day Indicator |
| 8. Auto Mode (A) | 19. Mode Selection Button |
| 9. Timer Indicator | 20. Power Button |
| 10. Upward Adjustment Button | 21. Power Switch |
| 11. Downward Adjustment Button | |

INSTALLATION

WARNING

- Fix the heater correctly on the wall or place the heater in the sturdy position.
- The heater should be installed so that the controls cannot be touched by a person using a bath or shower.
- The heater should be installed so that it is not located directly under a socket outlet.

CLEARANCES

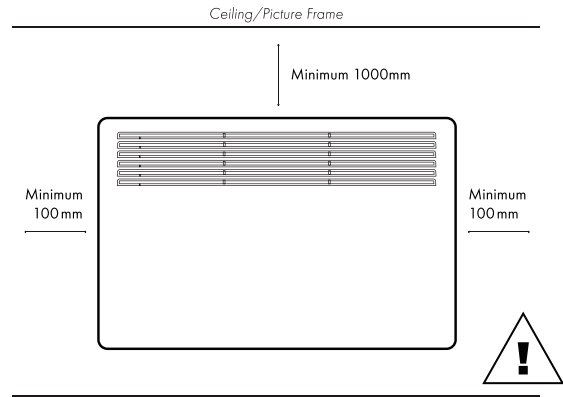

This heater **MUST** be installed to the minimum required distances at the four sides of the heater.

MOUNTING GUIDE

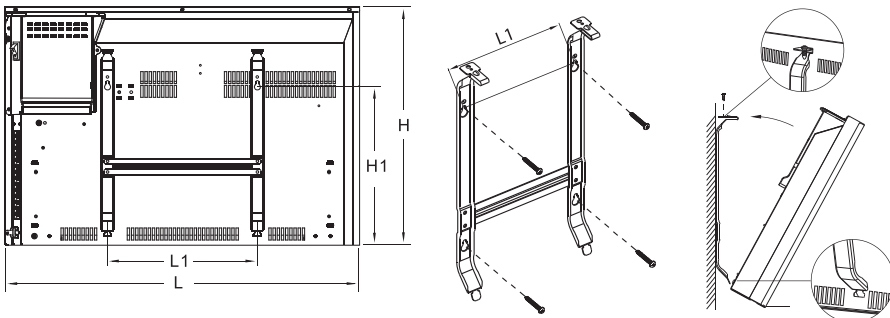

1. Insert the bracket (into the hole), turn it 90° anti-clockwise to fasten the screw
2. Press the rubber pad (in the hole), fasten it with the screw).

DELETE TIMERS

- Hold the OK button (12) for 5 seconds until a "di" tone is sounded, all prior daily and weekly timers will now be erased.

POWER OFF

- Press the power button (20) to turn the heater on or off. If you shut down the system while it is in automatic mode, it will work according to the scheduled procedure.
- However, if the unit is to be switched off for a long time, you must switch the system to manual mode and then off. If the system is outside the preset timer, it switches off 1 second after pressing the power button (20).

HALF POWER AND FULL POWER SELECTION

- Press the heating power button (2) to change the power to partial or full load.
- At full heating capacity, "HI" (5) is illuminated on the display and half heating capacity shows "LO" (4) is not illuminated.
- In the case of partial capacity heating, "LO" (4) is illuminated on the display and "HI" (5) is not illuminated on the display.

MANUAL MODE AND AUTO MODE

- Press the "M/A" mode selection button (19) to change the mode to Manual or Auto.
- In manual mode, the display (7) shows an "M" while the "A" is hidden on the display.
- In auto mode, the display (8) shows an "A" and the "M" is hidden on the display.

SHUTDOWN MEMORY FUNCTION

- Press the power switch (20) to turn the unit off and on again. When the unit is switched back on the temperature default is the last set and the previously scheduled timers are still activated.
- Auto Mode Timer and the Manual Mode Timer have a shutdown memory function.

SWITCHING OFF THE ELECTRICAL MEMORY FUNCTION

- If the unit is unexpectedly turned off or there is a sudden power failure, only the power indicator (1) lights up when the power is back on and the system is in standby.
- Press the power button (20) to turn the system back on. The system operates in the last mode in use before the power outage.

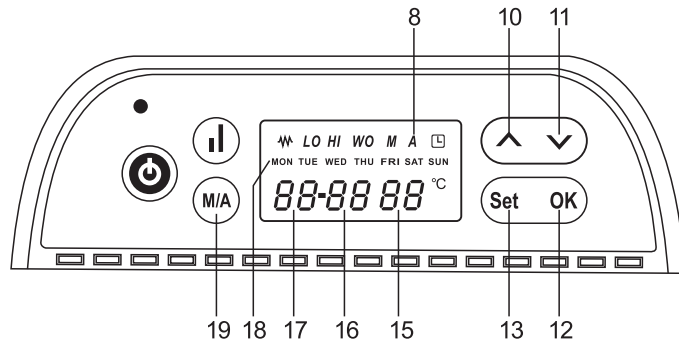

SETTING THE TIMER IN AUTO MODE (WEEKLY TIMER)

This setting is to control what time your heater comes on and off throughout the week. The desired temperature cannot be set differently for each segment. You can set four heating segments per day meaning that you can schedule up to four startup times and shutdown times per day. Timers can only be set in one-hour increments so when you have selected the weekday and the hours for the timer, if the display shows [09-14] for example, it means it will come on at 09:00 and go off at 14:00 and not that the timer is set to 09.14am.

1. Please make sure the Date and Time of the heater has been set first using steps from page 7.
2. Press the Manual/Auto mode selection button (M/A) (19) to select Auto mode. The display shows "A" when the unit is in Auto mode (8).
3. Press the Set button (13) so that the day of the week display (18) flashes.
4. Use the up button (10) and down button (11) to select the day of the week that you would like to set the timer for.
5. Press the Set button (13) again once the desired day is flashing and you will see that the hour indicator which is the left side of the time display is now flashing (17).
 - a. This will now let you select the startup hour of the first timer of the day using the up and down arrows.
 - b. You will know that this is the first heating segment selection because a 1 will be displayed on the temperature indicator display (15).
6. Once selected, press the Set button (13) again to confirm the start-up hour and use the up (10) and down (11) buttons to select the hour that the heater will turn off (16) in heating segment one. If the time it is due to turn on matches the time it is due to turn off, for example 10-10, the system cancels this heating phase.
7. Press the Set button (13) to confirm the first heating period.
8. Repeat the above procedure to set the timer for the remaining three segments.

If you do not wish to set any further heating segments press the Set button repeatedly until you reach the end of heating segment four or just press OK (12) after confirming the first segment and the heater will store solely the first heating segment.

CASTER INSTALLATION & REMOVAL

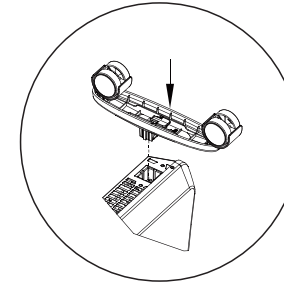

If the casters have been installed correctly
you will hear a click sound

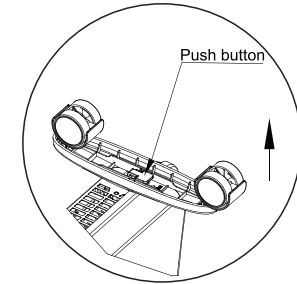

Push the button up to remove the caster

CASTER PACKAGING LOCATION

Castors are located within polystyrene side protection inside Packaging box.

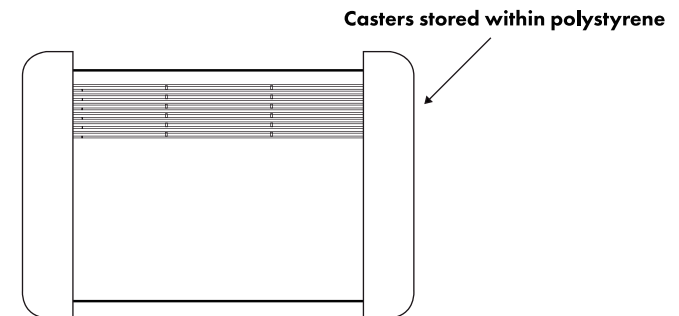

OPERATION

GETTING STARTED

- Carefully remove the heater from the box (keep the box for off-season storage).
- Ensure the power switch (21) is turned off before plugging the unit in.
- Make sure the heater is safely installed in accordance with the installation instructions.
- It is best to avoid using the heater in an outlet that is already being used for other high-power electrical equipment, to avoid overloading the circuit.

POWER ON

- When the product is connected to the power supply, the power indicator (1) will illuminate.
- Press the power button (20) to switch the unit on.
- The display shows the following settings:

The day indicator (18) shows the day of the week (default is MON = Monday), the hour display (17), the minute display (16), and the temperature display (15) in degrees Celsius (35 is the default). You will need to set the correct time, and this will then be stored in the heater. Auto mode (A) is enabled as the default. Note: If the device suddenly goes out during operation the system will continue working according to the last operating settings when switched back on.

SETTING THE DATE AND TIME OF HEATER

1. Hold the OK (12) and Set (13) buttons at the same time for 5 seconds until the day of the week display (18) flashes. If done correctly the unit will beep after 5 seconds.
 - If there is a beeping sound as soon as the buttons are pressed, it means you have accidentally pressed Set (13) first instead of holding them both down at the same time. If this happens, press OK (12) to go back to the start and try again.
 - Once held down correctly, the day that flashes is the day the heater is currently set to. For instance, if THU flashes, the heater thinks it is Thursday.
2. Use the up button (10) and down button (11) to select the current day of the week and confirm by pressing the Set button (13). The weekday indicator (18) will then stop flashing.
3. The hour display (17) will start flashing. Use the up (10) and down (11) buttons to select the hour. Press the Set button (13) to store the hour.
4. The minute display (16) will start flashing, use the up (10) and down (11) buttons to select the minutes. Press the Set button (13) to store the minutes.

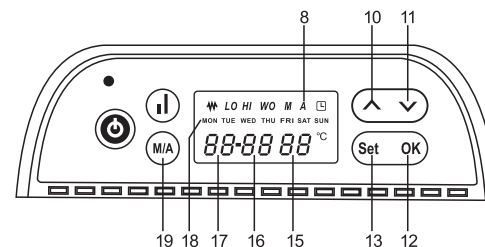

SETTING THE TEMPERATURE

- The unit of measure for the target temperature is °C in both Auto and Manual mode.
- When the heater is switched on, you can select the target temperature using the up (10) and down (11) buttons and then click the Set button (13) to confirm the desired temperature.
- If no action is taken for 10 seconds after the setting is completed, the system automatically saves the setting and exits the menu.
- Please note that after setting the desired temperature, the control panel will go back to displaying the temperature that the room is currently at but will turn off/ on according to the temperature you set it to. If the desired temperature has not been met, the heating indicator (3) will be illuminated to show the heater is still on.

SETTING THE TIMER

Setting the Timer in Manual Mode (24-hour timer)

This setting mode is to be used if you want to control the heater on a 'per-use' basis and when you want the heater to turn off at a specific time within 24 hours. For example, if you turn the heater on in the morning and want it to turn itself off in the afternoon.

1. Please make sure the Actual Date and Time of the heater has been set first using steps from page 7.
2. Press the Manual/Auto (M/A) mode button (19) to select the manual mode. The display shows "M" when in manual mode (7).
3. Press the Set button (13) to set the hour of the timer to turn off. Press the up (10) and down (11) buttons to select the hour (if the selected hour to turn off is earlier than the current time, the system automatically rolls over to the following day).
 - a. For example, if the current time is 10am and you set the timer to go off at 9.30am, the heater will turn off the next day at 9.30am.
 - b. For example, if this happens and it is a Wednesday, the display screen will then display THU instead of WED to show it will turn off the next day.
4. Press the Set button (13) to set the minute that the timer should turn off (if the set hour is identical to the current hour but the selected minute is less than the current minute, the system automatically rolls over to the following day).
 - a. For example, if the current time is 10.30am and you set the heater to go off at 10.24am, it will turn off the next day at 10.24am.
5. Press the OK button (12) to save and this will exit the timer setting.